



Four Stroke Karting Association of NSW 2021 Supplementary Engine Technical Specification

DOCUMENT ID: 4SKANSW2021SETSREV01

Effective from March 18, 2021

This rule package has been prepared by the Four Stroke Karting Association of NSW (4SKANSW) for the 4SKANSW 2021 Endurance Championship and is intended to establish the sole basis for technical control of the Briggs LO206 engine in that competition. This document overrides all engine related technical specifications stated in the 2021 Karting NSW Rule Book, Version 4, in particular, this rule package overrides the engine technical specifications outlined section E - Engine Regulations, E.4 - Four Stroke Engines, E.4.1 - Briggs & Stratton 206.

**UNLESS THESE RULES STATE THAT YOU
CAN DO IT, YOU CANNOT DO IT**

**This rule package covers all engine related technical
specifications.**

**For all other regulations beyond the engine please refer
to the Karting NSW 2021 Rule book.**

CONTENTS

1. 4SKANSW Endurance Racing Class	3
2. These Regulations Are the Only Regulations	3
3. The 3 Core Rule Set Technical Inspection Principals:	3
4. Briggs & Stratton 206 Product Availability	3
5. General Rules	3
6. Things That Are NOT Permitted	4
7. Engine Sealing	4
8. Technical Inspection Tools	5
9. Engine Ignition Switch.....	5
10. Engine Air Filter.....	5
11. Engine Fuel Requirements	5
12. Engine Oil.....	6
13. Oil Breather	6
14. Oil Catch Container	6
15. Carburettor Overflow	6
16. Fuel Pump	6
17. Cooling Shrouds, Covers and Blower Housings.....	6
18. Damaged Thread Repair	7
19. Carburettor & Intake Manifold	7
20. Cylinder Head	10
21. Head Gasket	10
22. Ports.....	10
23. Valves.....	11
24. Valve Springs.....	11
25. Rocker Arms, Rocker Ball and Rocker Arm Studs.....	12
26. Push Rods	12
27. Engine Block	12
28. Valve Lift.....	13
29. Camshaft Profile Limits.....	13
30. Flywheel.....	14
31. Ignition System and Ignition Timing.....	14
32. Crankcase	15
33. Clutch	15
34. Starter	16
35. Exhaust Header.....	16
36. Exhaust Silencer.....	16
37. Exhaust Protection.....	17

1. 4SKANSW Endurance Racing Class

Refer to the 2021 Karting NSW rule book for specific rules that relate to the 4SKANSW Endurance Racing category.

2. These Regulations Are the Only Regulations

- a. Only 4SKANSW can make changes to the technical specifications herein.
- b. Should any Briggs & Stratton (B&S) literature, catalogues, manuals, videos, etc. be different than these regulations, these regulations take precedence.
- c. Changes, corrections, addendums, etc. will be submitted to Karting NSW and posted at www.4skansw.com.au for republication and will become effective on a date specified.

3. The 3 Core Rule Set Technical Inspection Principals:

- a. Unless these rules state that you can do it, you cannot do it.
- b. Spirit and Intent: Covered, stated, restated, or unstated any change or action with the sole intent to wrongfully create a performance advantage is grounds for disqualification.
- c. All parts are subject to comparison with a known stock part. This includes specified and mandated aftermarket parts. Example: RLV exhaust and silencer.

4. Briggs & Stratton 206 Product Availability

The 206 engine products and service parts are available only through the authorised Briggs & Stratton Racing dealers and approved re-sellers.

A list of authorised dealers can be found at www.4skansw.com.au

5. General Rules

- a. The terms stock, original equipment, OEM, unaltered, etc., refer to Original Equipment supplied by Briggs & Stratton.
- b. Only the original equipment Briggs & Stratton 206 #124332-8201 engine is allowed in this class.
- c. All parts must be unaltered Briggs & Stratton 206 parts specifically made for this engine by Briggs & Stratton. No aftermarket parts to be used unless specified in these regulations.
- d. All parts are subject to comparison with a known stock part. This includes specified and mandated aftermarket parts. Example: RLV exhaust and Silencer.
- e. A tech official may use additional means of measuring components to compare against a known stock part.

- f. The tech official, at their sole discretion, may at the conclusion of an event request a competitors engine be forfeited for technical inspection. Failure to comply is grounds for disqualification.
- g. All Briggs & Stratton 206 engines must have a serialised block. Blocks without a factory serialisation on the front base next to the oil drain are illegal in competition.

6. Things That Are NOT Permitted

- a. Tampering of the factory installed engine seals, two (2).
- b. Addition or subtraction of material in any form or matter.
 - a. Exception – Valve maintenance (valve job). Valve seats must remain with the factory specification of 30 and 45 degree angles only. Valve seats of additional angles and/or angles not comparable to the factory stock of 30 and 45 degrees are not permitted. Grinding of valve stem or excessive material removal prohibited.
- c. Blueprinting.
- d. Modification to or the machining of any parts in order to bring them to stated minimum/maximum specification, (or for ANY reason).
- e. Machining or alteration of any kind to the engine or replacement parts unless specifically stated herein.
- f. Deburring, machining, honing, grinding, polishing, sanding, media blasting, etc. g. Sandblasting or glass-beading any interior engine surfaces.
- h. No device may be used that will impede, or appear to impede, airflow to the engine cooling system.

7. Engine Sealing

There are two custom security seals with matching serialization installed from the factory. Tampering of the seals is not permitted. Should the seals be tampered with, the engine is no longer eligible for competition.



Seals can have either a black anodized or bare aluminium finish on both main body ends as shown.

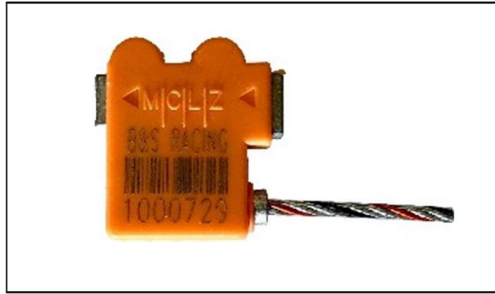

Beginning on 30/5/18 our latest seal features a red and black custom wire, orange housing, etched 'B&S Racing' type, and matching seal serial numbers.

Each competitor is responsible for the condition of their seal. We recommend that each seal be wrapped (plastic bag, etc.) to prevent exposure from harsh cleaners, degreasers, and oils.

8. Technical Inspection Tools

4SKANSW have a range of tech inspection tools that will be used to measure engine components at race meetings

9. Engine Ignition Switch

The B&S ignition switch and wires must remain in stock location. It is not permitted to alter the OEM wiring.

10. Engine Air Filter

The only air filters permitted are as follows:

Briggs & Stratton Green Air Filter Part #555729

Briggs & Stratton Green Air Filter Part #555758

Uni Filter Foam Air Filter Part #UP4112A

A protective shield may be attached for wet-weather competition.

No modification to the filter element is permitted other than for the purpose of attaching a rain cover directly to the air filter element. For the purpose of attaching a rain cover, holes may be created in either or both ends of the air filter element. All holes must be completely filled with fasteners, there can be no clearance between the hole(s) and the fastener(s) and there can be no holes without fasteners.

It is not permitted for the protective shield to create any ram-air effect.

A fabric prefilter is allowed as long as it does not create a ram-air effect.

The air filter must remain in place for the entire duration of the race. If the air filter falls off during the race, the kart must immediately return to the pits and replace the air filter.



Part #555729



Part #555758

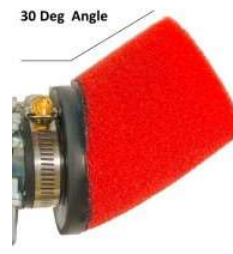

#UP4112A

11. Engine Fuel Requirements

The addition of fuel additives in any manner is not permitted.
Fuel type and brand will be specified in the Event Supplementary Regulations.

12. Engine Oil

No oil additives are permitted.

13. Oil Breather

Oil breather must vent to a catch container.

14. Oil Catch Container

An oil overflow catch system is mandatory. Overflow tube must run from the crankcase breather to a catch container. The catch-container must be vented to atmosphere.

15. Carburettor Overflow

Carburettor overflow must be vented to a catch container. The catch-container must be vented to atmosphere.

16. Fuel Pump

Only fuel pump, B&S part number 808656 or 597338, is legal for competition. This fuel pump can be identified by the Briggs & Stratton diamond logo on the pump face. All other pumps are prohibited.
Relocation of the fuel pump is not permitted other than to space the fuel pump up from the engine plate. The maximum height of the spacer permitted is 20mm. Vertical mounting or mounting the fuel pump upside down is NOT allowed. It is permitted to obtain the pulse from a pulse fitting in the crankcase or the cylinder head intake port. Aftermarket one-piece filler/pulse fittings are permitted. Oil catch chambers are permitted to be placed in the pulse line between the pulse fitting and the fuel pump if the pulse is sourced from the a pulse fitting in the crankcase. Check valves are prohibited.

The use of silicone sealant on the brass vent is permitted.
A fuel pump return line to the fuel tank is permitted and must be a direct line and must not be fitted with an adjustable restrictor of any kind.

A fuel filter is not required but highly recommended to ensure that dirt and contamination within your fuel system does not impact your carburettors performance.

The fuel filter itself is not a tech item but only one fuel filter is legal for use and it can only be located between the fuel tank and fuel pump inlet (not between the pump outlet and carburettor).

17. Cooling Shrouds, Covers and Blower Housings

All pieces of the engine cooling shroud/blower housing and control panel must be stock B&S and properly installed. Rewind housing and cooling shroud (air guard) must remain stock as painted from the factory.

Engine Shroud may be painted any colour. Any bolt, with the exception of the head bolt, that is used to secure sheet metal shrouds and covers may be replaced with larger diameter bolts.

No taping, covering, or restricting of air to the rewind shroud is permitted.

18. Damaged Thread Repair

It is permitted to use Heli-coil, Time-sert or a similar thread repair insert for shrouds, valve cover, oil drain, oil fill holes, blower housing, and exhaust pipe attachment studs on the head and lower brackets.

19. Carburettor & Intake Manifold

The B&S stock carburettor part #555658 is the only carburettor permitted. 'Walbro', 'Briggs' diamond logo and/or #590890 etched in the body are additional visual indicators. No alterations allowed unless stated below. All parts will be compared to a stock known B&S part for eligibility. This includes the nozzle, emulsion tube, jets, float, float needle and all other carb parts. It will be allowed however to adjust the float height by means of bending the small tab on the float arm.

A slight chamfer around the choke bore ID (air horn) may be present. 1.149" no go tech tool to be used.



Both idle and main jet must remain stock, as shipped from the factory. Drilling of jets is not permitted.

Slide must remain B&S stock unaltered. Slide cutaway to be measured on flat surface. .075 no go tech tool to be used. ALL intake manifold fasteners to remain factory stock. The use of studs, etc. are illegal.

All individual carburettor components must be tight, as shipped from the factory.

B&S stock unaltered aluminium needle is required part number 555602 marked #BGB. Needle to be inspected using tech tools. Needle, when placed in tool, should not protrude through the other side. If needle protrudes through the block it is out of specification.

Throttle cable cap on the top of the carburettor must be properly installed and secured in the fully tight position.

Metal choke cover must remain in place but may be secured with silicone or epoxy sealer. Additional pin punching is allowed to tighten choke cover.

Air must only enter the engine from the natural air filter horn of the carburettor. Air entering through any other method is illegal. An approved spray test method can be used for tech validation.

The intake manifold may be reinforced by the addition of a brace that runs parallel to the tube section and sits between the mounting flanges. The addition of the bracing must not alter the internal size or shape of the tube section.

Caution: Induction welding may induce warpage or distortion, this would result the intake manifold not complying with these rules

The intake manifold may be fitted with a fuel pump pulse fitting. The addition of the pulse fitting must not alter the internal size or shape of the tube section. The hole that is drilled in the tube section must not exceed 3.20mm in diameter. This will be checked during tech inspections of this item.

<p>Idle Pilot Jet - Stock, Unaltered .0130" No-Go (Use .0130" Class Z No-Go)</p>	<p>Emulsion Tube - Stock, altered Small Holes - .018 Go (Use .018" Class Z Go) .021" No-Go (Use .0215" Class Z No-Go) Big Holes - .026" Go (Use .026" Class Z Go), .029" No-Go (Use .029" Class Z No-Go)</p>
---	---

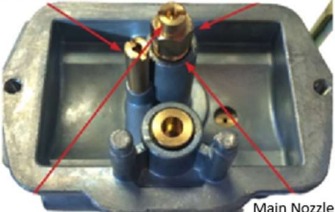

<p>Main Jet - Stock, Unaltered .0365" Go (Use .0365" Class Z Go), .039" No-Go (Use .039 Class Z No-go)</p>	<p>Main Nozzle - Stock, Unaltered .101" Go (.101" Class Z Go) .104" No-Go (Use .104" Class Z No-Go)</p>
---	--

Venturi Horizontal Measurement - (Tool A20)
(narrowest part) = .602" No-go
can't pass into the slide area.

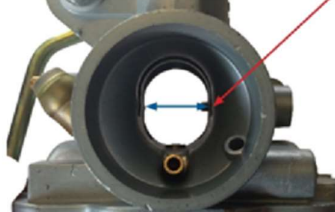

<p>Venturi Horizontal Measurement- (Tool A8) (widest part) = .615" No-go can't pass into the slide area.</p>	<p>Venturi Vertical Measurement- (Tool A8) .792" No-go can't pass into the slide area.</p>
---	---

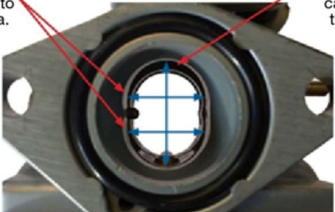

Venturi Idle Fuel Hole -
.039" No-Go (Use .039" Class Z No-go)
Use pin gauge and access from the slide opening.



<p>Air Pick Off Hole - .057" Go (Use .057" Class Z Go), .061" No-Go (Use .061" Class Z No-Go)</p>	<p>Venturi Idle Air Hole - .119" No Go (Use .1195" Class Z No-Go)</p>
--	--

NOTE: Slide openings will be measured with the appropriate tech inspection tool.

Technical Item	Description	Tech Tool
a. Needle Jet C-Clip	Needle Jet C-clip must be properly installed but may be installed at any of the 5 factory settings on the needle jet.	
b. Throttle Cable Cap	Throttle cable cap on the top of the carburetor must be used and properly installed in tight position.	
c. Choke	Choke: OEM unaltered, but lever may be fastened open with a spring, rubber band, wire, etc.	
d. Idle Pilot Jet	Idle Pilot Jet – Stock, Unaltered .0130" No-Go (Use .0130" Class Z No-Go)	
e. Idle Circuit Air Hole	No drilling, reaming, elongating of the hole allowed. .119" max. diameter. A small chamfer at the outer edge, as compared to a stock part, can be present. The measurement of that chamfer is subject to sanctioning body guidelines.	.1195" Pin gauge
f. Main Jet	Main jet – Stock, Unaltered .0365" Go (Use .0365" Class Z Go), .039" No-Go (Use .039 Class Z No-go)	
g. Emulsion Tube	Main nozzle – OEM stock unaltered hole size = .101, .104" Small holes – .018 Go (Use .018" Class Z GO) .021" No-Go (Use .0215" Class Z No-Go) Big Holes - .026" Go (use .026" Class Z Go), .029" No-Go (Use .029" Class Z No-Go)	
h. Venturi Measurement	Venturi Measurement: Vertical: .792 max inches.	A8
	Horizontal: .615 max inches at widest part	A8
	Horizontal: .602 max inches at narrowest part.	A20
i. Air Pick Off Hole	Air pick off hole - .057 go .061 no go	A9
j. Throttle Bore	Throttle bore – Must be as cast and bore max diameter = .874 inches.	A7
k. Venturi Idle Fuel Hole	Venturi idle fuel hole = .039" No-Go (Use .039" Class Z No-go)	
l. Air Filter	Air filter: Only GREEN air filter, part # 555729 is allowed. Filter adapters are not allowed, filter must attach directly to carburetor air horn	
m. Carburetor Overflow	Carburetor overflow: Must be vented to a catch container.	
n. O-Ring	O-Ring part number B&S part # 555601 is required and must be unaltered.	A12
o. Intake Manifold	Intake manifold – max length = 1.740 inches min to 1.760 inches max	
	Intake manifold – bore diameter = .885 inches min to .905 inches max	A11
p. Choke Bore/Air Horn	1.149 no-go	A7
q. Carb Slide Cutaway	.075 no-go	A10
r. Widest part of Combustion Chamber	2.640	A30

20. Cylinder Head

NOTE: The cylinder head, head gasket and valves are controlled items with 4SKANSW. Some of the rules in this section are stated for the reference of the approved engine inspectors.

a. The ONLY head casting for the B&S 206 herein is the 'RT-1', cast into the head just off the head gasket surface (towards the rear of the engine, PTO side). The overall head minimum thickness is 2.431".

b. Cylinder head must be "as cast". Factory machining marks left on the head gasket surface is NOT a tech item.

c. Hard carbon may be scraped from head before measuring.

d. Depth of shallow area of combustion chamber must be .031 inch minimum. This measurement to be taken with a depth gage on both the combustion side and spark plug side of cylinder head.

e. Depth of the combustion chamber is .342" inches minimum.

f. Inspect retainers for alterations that would increase valve spring pressure - .055 to .075 maximum flange thickness. Both intake and exhaust must have OE stock B&S valve keepers.

g. Unaltered B&S part #555552 (exhaust) and #555551 (intake) valves can be checked for appearance, weight, and dimensions. No machining, polishing, easing, or alterations of any kind allowed. Valve surface must remain as factory, with one single 45 degree face. No other additional angles allowed on any part of the valve.

h. Valve Guides: Replacement of valve guides with B&S part #555645 only is allowed. Maximum depth from the head gasket surface to the intake valve guide is 1.255".

i. Briggs & Stratton heat disperser, p/n 555690 can be installed in the exhaust bolt boss per factory instructions.

j. Valve seats may be cut by approved engine sealers only. Re-cut valve seats are to be cut at 45 degrees and then a second 30 degree relief cut above the valve seating surface is permitted. Three (3) angle valve seats are not permitted. Relief cuts below the valve seating surface are not permitted.

21. Head Gasket

a. Unaltered B&S part #555698 & #555723 are the only head gaskets allowed.

22. Ports

a. No de-burring, machining, honing, grinding, polishing, sanding, media blasting, etc.

b. The transition from intake bowl to port must have factory defined machining burr at this junction. No addition or subtraction of material in any form or matter.

No alterations of any kind may be made to the intake or exhaust ports.

- c. Intake Port: Maximum diameter measurement = .918 inches max.
- d. Exhaust Port AS CAST. Exhaust Outlet -.980 inches.
- e. Valve Seats. Intake and exhaust: Must remain factory specification with one 30 and one 45 degree angle only. Valve seats of additional angles and/or angles not comparable to the factory stock are not permitted.
- f. Valve maintenance permitted. Valve seats must remain with the factory specification of 30 and 45 degree angles only. Valve seats of additional angles and/or excessive material removed when compared to the factory stock is prohibited.
- g. Intake valve seat diameter inside = maximum .972 inches.
- h. Intake port pocket bowl (area just below valve seat) = .952 inches.
- i. Exhaust valve seat diameter inside = maximum .850 inches.
- j. It is permitted to drill the cylinder head and install a fuel pump pulse line fitting into the intake port. The fitting must not protrude into the port.

23. Valves

a. Intake valve

Minimum Weight of Valve	27.8 grams
Diameter of valve stem	.246 to .247 inches
Diameter of valve head	1.055 to 1.065 inches
Diameter of valve seat	.972 inches ID maximum
Valve length	Minimum 3.3655 inches
Height from angle of valve face to top of the valve	.057 inches minimum

b. Exhaust valve

Minimum Weight of Valve	27.2 grams
Diameter of valve stem	.246 to .247 inches
Diameter of valve head	.935 to .945 inches
Diameter of valve seat	.850 inches ID maximum
Valve length	Minimum 3.3655 inches
Height from angle of valve face to top of the valve	.060 inches minimum

24. Valve Springs

- a. Valve Springs are single coil stock, unaltered B&S part #26826. Must be identical in appearance to factory part and have 4.00 to 4.75 coils in stack.

b. Spring Wire Diameter: .103 to .107 inches

c. Valve spring length including any shims: .940 max inches

Inside diameter: .615" Go, .635" No-Go

25. Rocker Arms, Rocker Ball and Rocker Arm Studs

a. Rocker arm must be stock B&S part #555711 (US) or #797443 (METRIC) and may not be altered in any way.

b. Rocker studs must be stock, unaltered B&S part #694544 US (1/4-28 thread) or #797441 Metric (M8x1.00 thread) and in stock location.

Rocker arm #555711 (US) must be used with rocker stud #694544 (US).

Rocker arm #797443 (Metric) must be used with rocker stud #797441 (Metric).

c. Rocker Ball must B&S stock. Diameter .590 inch min. to .610 inch maximum.

d. Rocker arm mounting positions may not be altered in any manner. No heli-coiling of mounting holes. No bending of studs.

e. Rocker arm stud plate must be bolted to the head with one, OEM stock B&S gasket only – no alterations. Maximum thickness of gasket is .060 inches. Rocker plate to head fastener holes must remain stock, .289" max.

f. Rocker arm – overall length 2.820 inch minimum.

26. Push Rods

a. Push rods must be unaltered stock B&S part #555531.

b. Push rod diameter .183 minimum inches to .190 maximum inches. Push rod length 5.638 minimum inches to 5.658 maximum inches.

c. Push rod diameter to be checked 3 points along the length and must pass two planes on each 360 degrees of rotation.

27. Engine Block

a. Engine block must be unaltered "as cast" B&S factory machined condition. There must be no addition or subtractions of metal or any substance to the inside or outside of the cylinder block.

b. Both, two (2) B&S engine seals must be present with both the fastener and seal in "as shipped" from the factory location and condition.

Any defined tampering with the fasteners or damage to the wire/seal itself (example: delaminated hologram) are grounds for disqualification.

Take proper care of your seals to ensure their integrity. It is recommended that you wrap your seals (using a plastic bag, etc.) to prevent exposure to harsh solvents such as carb cleaner, etc...

c. Deck gasket surface finish is a controlled item with 4SKANSW. Piston pop up can be .0035" maximum. Piston pop-up to be checked with flat bar in centre of piston parallel to piston pin and then again checked 90 degrees to piston pin. Piston is to be pushed down to take up rod play.

Angle milling or peak decking is not allowed.

d. Carbon build-up can be removed before pop-up is measured as long as material is not removed from the piston. Exception – Approved inspectors can deburr the manufacturing part number/marks IF needed as long as:

- Removal does not extend beyond the defined script area.
 - De-burring does not extend below the original piston surface area.
 - The original part numbers and script are still clearly visible.
- e. Cylinder bore will not be bored oversize
- f. Cylinder bore will not be re-sleeved.

g. Cylinder bore position is not be moved or angled in any manner.

h. Cylinder bore dimension: - Briggs & Stratton stock bore is 2.690". Allowance for wear is permitted up to 2.693" maximum for entire length, top to bottom.

i. Maximum stroke is 2.204". Push piston down to take up rod play. Stroke is by measuring the stroke distance from BDC to TDC.

28. Valve Lift

a. Maximum valve lift is checked from the top of the valve spring retainer. Valves must be adjusted to zero clearance.

b. Valve Lift: Camshaft check is taken at the valve spring retainers. With the lash set at zero, the movement of the valve spring retainers may not exceed the following: Intake and exhaust: .255 inches maximum.

29. Camshaft Profile Limits (measured at the push rod)

Push gently down on dial indicator stem to ensure that there is no lash when push rods are going down.

NOTE: Due to the extended life of the engine, a single referenced point on each lobe can be off by a maximum of 2 degrees without issue, the exception being on the .006" check, both intake and exhaust.

Intake lift		Exhaust lift	
0.006	59 TO 51 BTDC	0.006	101 TO 93 BBDC
0.020	16 TO 12 BTDC	0.020	59 TO 55 BBDC
0.050	.5 TO 4.5 ATDC	0.050	43 TO 39 BBDC
0.100	17 TO 21 ATDC	0.100	26 TO 22 BBDC
0.150	33.5 TO 37.5	0.150	9 TO 5 BBDC
0.175	43 TO 47 ATDC	0.175	1 TO 5 ABDC
0.200	54 TO 58 ATDC	0.200	11.5 TO 15.5
0.225	68 TO 72 ATDC	0.225	25 TO 29 ABDC
MAX LIFT	0.257	MAX LIFT	0.259
MIN LIFT	0.252	MIN LIFT	0.252

Intake lift		Exhaust lift	
0.225	38 to 34 BBDC	0.225	76 TO 72 BTDC
0.200	24.5 TO 20.5	0.200	62.5 TO 58.5
0.175	14 TO 10 BBDC	0.175	52 TO 48 BTDC
0.150	4.5 TO .5 BBDC	0.150	42 TO 38 BTDC
0.100	12 TO 16 ABDC	0.100	25.5 TO 21.5
0.050	29 TO 33 ABDC	0.050	8.5 TO 4.5 BTDC
0.020	45.5 TO 49.5	0.020	8 TO 12 ATDC
0.006	83 TO 91 ABDC	0.006	47 TO 55 ATDC

30. Flywheel

NOTE: The flywheel is a controlled item with 4SKANSW. Some of the following rules are provided for the reference of the approved engine inspectors.

- a. No modifications are allowed to the flywheel.
- b. The minimum weight of the flywheel, fins and attachment bolts is 4 pounds 1 ounce.
- c. Stock B&S part #555683 only. No machining, glass beading, sand blasting, painting or coating of flywheel is allowed.
- d. A flywheel fan, B&S part #692592, with broken fins must be replaced.
- e. Stock, unaltered B&S flywheel key with the B&S logo is required. Width of the key allowed is .1825"-.1875". No offset keyways allowed.

31. Ignition System

NOTE: The ignition system is a controlled item with 4SKANSW. Some of the following rules are provided for the reference of the approved engine inspectors.

- a. Unaltered B&S stock ignition part #555718 is mandatory. Only "GREEN" ignition module allowed. Maximum RPM: 6,150.
- b. Coil or its position, other than air gap may not be altered in any way. Coil mounting bolts must be stock and cannot be altered in any way to

advance or retard timing. Attachment bolts and/or bolt holes may not be altered.

- c. Spark plug: Only the B&S unaltered factory spark plug part number #555737 or Champion RC12YC is permitted. Spark plug must have the "Champion" logo as well as the RC12YC identification on the insulator. Sealing washer must be in place, unmodified as from the factory. Temperature thermocouple permitted as long as sealing washer and/or air guard are not modified.
- d. Spark plug connector: Only the OEM B&S part #555714 is permitted.
- e. Magneto air gap is a controlled item with 4SKANSW (recommended clearance of .016")
- f. Static check for timing:

- Install a degree wheel using a positive stop method.

- With the left edge of the first magnet aligned with the start of the lead leg of the ignition (refer to photo), the engine must not exceed 26 degrees with air gap set at .016". Timing checked in the direction the engine operates.

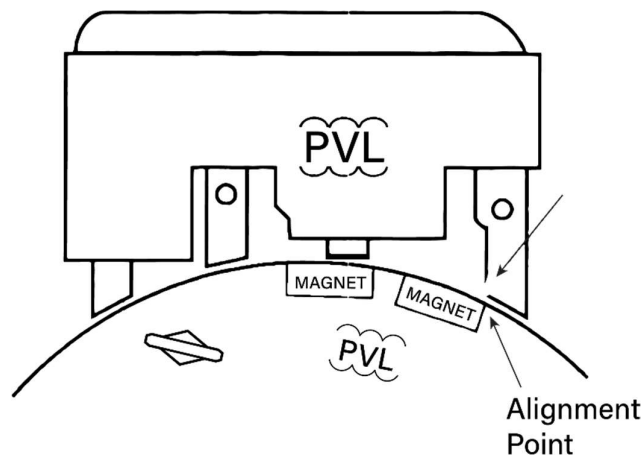

NOTE: The ignition timing is a controlled item with 4SKANSW. The proceeding information is provided for the reference of the approved engine inspectors.

32. Crankcase

Crankcase and cover must be Briggs & Stratton stock, unaltered, "as cast in factory" condition. No alterations or subtractions of metal or any other substance to crankcase cover.

33. Clutch

- a. The clutch must be a standard Hilliard Inferno Flame, Hilliard part number: LD4S-FLAME
- b. The clutch must be fitted with four (4) White Hilliard Inferno Flame springs, Hilliard part number 8443-35-005-A
- c. The maximum number of springs permitted is four (4) (no doubling up of springs)

- d. Springs can and will be tested to ensure they are genuine white Hilliard Inferno Flame springs, part number 8443-35-005-A
- e. Clutch shoe weights are not permitted in any form this includes standard Hilliard weights or any other form of added material that adds weight to the clutch shoe(s). The filling of any holes in the shoes in any way is not permitted
- f. The clutch can be installed with the sprocket positioned either inboard or outboard. Inboard is considered to be when the drive sprocket is located between the clutch and the engine. Outboard is considered to be when the sprocket is located between the clutch and the retention bolt and washer.
- g. The clutch shoes can be installed in either a "Leading" configuration or "Trailing" configuration.
- h. Permissible sprocket sizes are 16, 17, 18, 19, 20, 21 & 22
- i. Sprockets and chain must be #219 pitch

34. Starter

Manual recoil starter, B&S part #695287, must be retained, as produced and intact. Starter may be rotated.

Electric starters are not permitted.

35. Exhaust Header

- a. Header must be RLV Model 5507.
- b. Header length will measure 18.75" +/- .25" along the short side using a 0.250" wide tape measure.
- c. Gasket and/or silicone are allowed to seal header to head. (One gasket maximum)
- d. Studs or bolts are permitted to fasten header to head. Bolts or nuts must be safety wired.
- e. Helicoiling of the exhaust is allowed.
- f. Supplied header support brace is mandatory. The addition of a mechanical support bracket (no welding involved) is allowed provided that there are no alterations to the shape or dimensions of the exhaust configuration. The cylinder head post that the rear exhaust support bolts to can be drilled through to facilitate the use of a long bolt and nut to secure the rear exhaust support brace to the cylinder head.
- g. Any modification for or use of an O2, EGT, CO2 sensor is prohibited.
- h. Welding the silencer to the header pipe is permitted so long as it does not cause any change to the size or shape of header pipe tube

36. Exhaust Silencer

Silencer must be RLV B91XL (IKD99) (part number 4104) with round baffle holes only.



The silencer may be welded to the header as long as the silencer is positioned in same location as it would be if it were only clamped in place. The welding of the silencer to the header pipe must not increase or decrease the overall length of the exhaust system. The clamp must still be installed and tensioned in its normal location. The welding must not change the internal size or shape of the silencer. Tethering of the silencer to header or header support bracket is mandatory, even if welded.

All 4 baffles must remain unaltered and the hole size can be verified using a no-go pin of .1285.

Exhaust gases may only exit through the muffler baffles.

Muffler must be mounted on the header in a way that does not allow exhaust to leak at this joint. The exception, if a header becomes loose (header bolts loosen) during a race but remains mounted to the head this not grounds for disqualification.

37. Exhaust Protection

The header must be completely wrapped (360 degrees) with a non-asbestos, approved insulation material or sleeve starting approx. 75mm from the exhaust flange but MUST extend to where the stock supplied RVL support (welded or clamped) meets the header.

UNLESS THESE RULES STATE THAT YOU CAN DO IT, YOU CANNOT DO IT